



User Manual

Industrial Borescope PCE-VE 100N4



User manuals in various languages (français, italiano, español, português, nederlands, türk, polski, русский, 中文) can be found by using our product search on: www.pce-instruments.com

Last change: 14 January 2022
v1.0



Contents

1	Safety notes	1
2	Technical specifications	2
3	Delivery scope	2
4	Device description	3
4.1	Keys.....	3
4.2	Interfaces	4
5	Start-up	5
5.1	First steps	5
5.2	Display indication	5
5.3	Probe control.....	6
5.4	Menu functions.....	6
5.5	Recording images and videos	8
5.6	Recalling the saved data	8
6	Troubleshooting	8
7	Warranty	9
8	Disposal	9

1 Safety notes

Please read this manual carefully and completely before you use the device for the first time. The device may only be used by qualified personnel and repaired by PCE Instruments personnel. Damage or injuries caused by non-observance of the manual are excluded from our liability and not covered by our warranty.

- The device must only be used as described in this instruction manual. If used otherwise, this can cause dangerous situations for the user and damage to the meter.
- The instrument may only be used if the environmental conditions (temperature, relative humidity, ...) are within the ranges stated in the technical specifications. Do not expose the device to extreme temperatures, direct sunlight, extreme humidity or moisture.
- Do not expose the device to shocks or strong vibrations.
- The case should only be opened by qualified PCE Instruments personnel.
- Never use the instrument when your hands are wet.
- You must not make any technical changes to the device.
- The appliance should only be cleaned with a damp cloth. Use only pH-neutral cleaner, no abrasives or solvents.
- The device must only be used with accessories from PCE Instruments or equivalent.
- Before each use, inspect the case for visible damage. If any damage is visible, do not use the device.
- Avoid excessive bending, stretching, twisting or rolling of the cable as this may cause the cable to break.
- Clean the front part of the instrument in time after finishing use to avoid corrosion.
- The measuring device must not be used in an explosive atmosphere.
- Do not use the product to check live objects to avoid electric shock.
- Never look directly into the LED light source at the end of the lens to avoid eye injury.
- Non-observance of the safety notes can cause damage to the device and injuries to the user.
- **This instrument is NOT suitable for medical purposes!**

We do not assume liability for printing errors or any other mistakes in this manual.

We expressly point to our general guarantee terms which can be found in our general terms of business.

If you have any questions please contact PCE Instruments. The contact details can be found at the end of this manual.

This product does not contain any spare parts that can be repaired by the user. Any disassembly, reassembly or maintenance is not permitted. Should any damage or loss occur as a result, we will not accept any liability. Product maintenance must only be carried out by authorised dealers and distributors.



2 Technical specifications

Model	PCE-VE 100N4
Cable / head diameter	Ø 6 mm / 0.23"
Camera head length	13 mm (±0.3 mm) / 0.51" (±0.01")
Cable length	1 m / 3 ft 2"
Camera pixels	1,000,000
Depth of field	7 ... 110 mm / 0.27 ... 4.33"
Field of view	120°
Swivel range	360°
Illuminance	five levels, adjustable up to 25,000 lx
Cable material	tungsten, braided
Bending radius	>220°
Display	3.5" IPS
Display resolution	640 x 480 pixels
Image and video format	JPG / MP4
Image and video resolution	960 x 720 pixels / 1280 x 720 pixels
Magnification	5x
Protection class	cable: IP67 display: IP65
Memory	16 GB micro SD card
Power supply battery	1 x 3.7 V 3200 mAh 18650 battery
Power consumption	3.5 W
Operating time	>3 h
Power supply mains operation	primary: 100 ... 240V AC, 50 ... 60 Hz, 0.35 A secondary: 5 V DC, 2 A
Interface	mini-HDMI (image transmission) micro-USB connector (charging port)
Storage conditions	-10 ... +63 °C / 14 ... 145 °F, <92 % RH, non-condensing
Operating conditions display*	-10 ... +50 °C / 14 ... 122 °F, <92 % RH, non-condensing
Operating conditions camera*	-10 ... +80 °C / 14 ... 176 °F, <92 % RH, non-condensing
Dimensions	277 x 106 x 92 mm / 10.9 x 4.1 x 3.6"
Weight	approx. 500 g / 17.6 oz

*At temperatures below 0 °C / 32 °F, the display must be pre-heated and the camera head must not be swivelled completely.

3 Delivery scope

- 1 x 4-way borescope PCE-VE 100N4
- 1 x 3.7 V 18650 battery
- 1 x micro USB cable
- 1 x USB mains adaptor
- 1 x micro SD memory card
- 1 x micro SD card adaptor
- 1 x carrying case
- 1 x screwdriver
- 1 x user manual



4 Device description

4.1 Keys

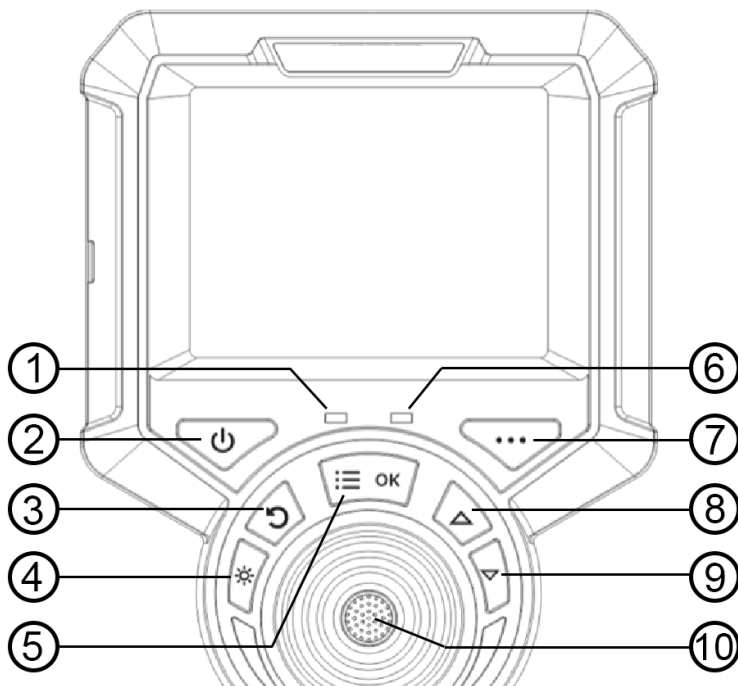

1. On/Off indicator light: flashes twice when the instrument is switched on and when taking images and videos.
2. ON/OFF key
3. Back key: in the menu, you can return to the next upper menu level
4. LED light: switch on the light, press repeatedly to increase the brightness in 5 steps, then it goes off.
5. Menu/OK: calling up the menu, confirmation key, switching between the settings depending on the menu item
6. Charging indicator
7. Key without function
8. Arrow key: In the menu, this key can be used to move to the left
9. Arrow key: In the menu, this key can be used to move to the right
10. Recording key: initiation of images and videos

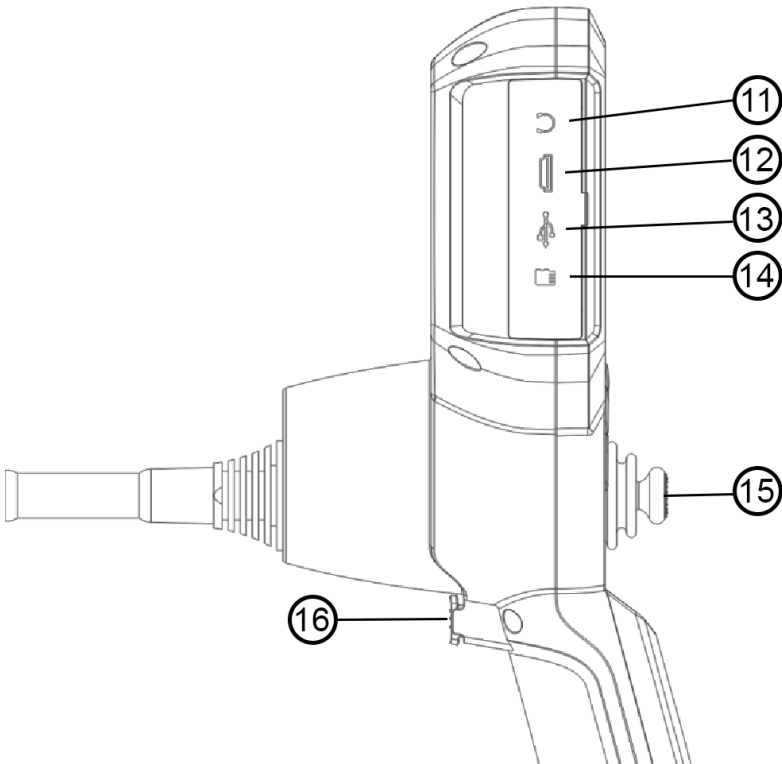

11. Headphone jack not available

12. HDMI video output: for the output of video signals

13. Micro USB charging port: for charging the device, voltage 5 V / current 1 A

14. SD card slot: for external SD card, as device memory

15. Joystick: 360° control of camera head

16. Recording key: initiation of images and videos

5 Start-up

5.1 First steps

Open the carrying case, remove the handheld unit and set it aside. Be careful when removing the probe cable and avoid collisions with hard surfaces and objects as well as scratches on the probe lens.

Visually check that the videoscope is intact, insert the SD card, straighten the insertion tube and set the direction of the probe to 0°.

5.2 Display indication

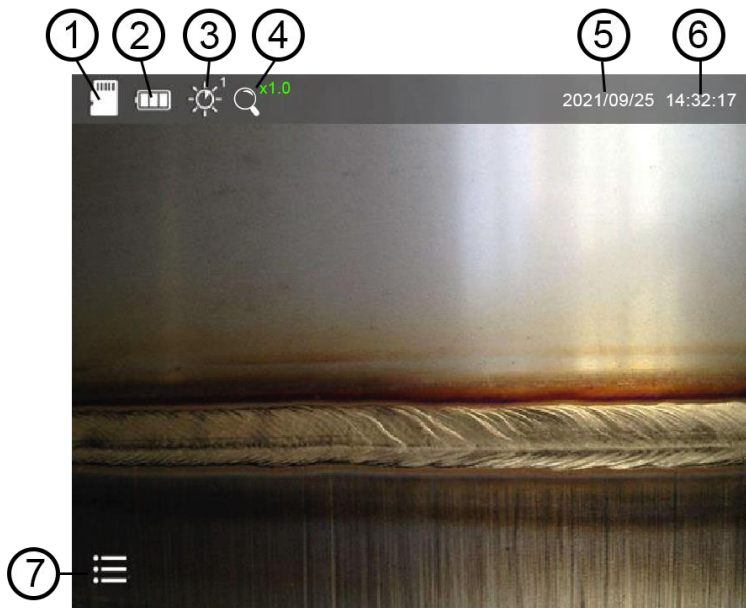

1. SD card - If the icon is red with an X, no SD card is inserted.
2. Battery status display
3. LED brightness - the brightness level is displayed at the top right of the icon
There are 5 brightness levels.
4. Zoom x1...x5 (adjustable in steps of 0.5)
5. Date
6. Time
7. Menu icon

5.3 Probe control





Keep the cable below the flexible camera head. Now make some test movements via the joystick and check whether the head moves properly. If you notice any resistance in the joystick control during use, stop the application immediately. Straighten the sensor head and remove the cable from the item under test. Visually inspect the cable.

5.4 Menu functions





To open the function menu, press the "OK" key. The function menu appears at the bottom edge, as shown in the picture. You can now select between the functions with the arrow keys. The selected function is marked in the centre with a green arrow and can be confirmed with the "OK" key. To exit the secondary menu options, press the back key.



5.4.1 General settings



	<p>System setting. Press the "OK" key to access the secondary menu options. A new window opens and the following functions are available.</p>
	<p>Formatting the memory card. You will be asked to select "NO" or "YES" with the arrow keys; then confirm with the "OK" key. Please note that data that has not been saved will be lost.</p>
	<p>Time / date setting. Use the arrow keys to change the digits and confirm with "OK", this will then lead you to the next setting field. If all settings are correct, press the back key to exit this function and save the data.</p>
	<p>Reset to factory settings. In this menu, you restore the factory settings. You will be asked to select "NO" and "YES" with the arrow keys; then confirm with the "OK" key.</p>
	<p>The instrument's serial number and the firmware version are displayed directly under info. Further data cannot be called up.</p>

5.4.2 Image settings

	Setting the image parameters. Press the "OK" key to call up the secondary menu options. A new window opens for this and the following functions are available
	Setting the brightness parameters. Use the arrow keys to change the value and confirm it with "OK".
	Setting the gamma value. (correction factor for greyscales) Use the arrow keys to change the value and confirm with "OK".
	Setting the sharpness of the image. Use the arrow keys to change the value and confirm it with "OK".
	Restore default parameters. This item allows you to restore the default image parameters. When this item is selected, you only have to press one of the arrow keys to restore default parameters.



5.4.3 Image effects

If you confirm this item with the "OK" key, another window does not open but you immediately switch to the next mode. Press again to switch to the next mode. Only by pressing the arrow keys, you switch to the next setting menu.

	Normal mode
	Warm mode
	Cold mode



5.4.4 Freeze image

If you confirm this item with the "OK" key, another window does not open but you immediately switch to the next mode. Press again to switch to the next mode. Only by pressing the arrow keys, you switch to the next setting menu.

	Freeze preview image
	Unfreeze preview image



5.4.5 Scaling

If you confirm this item with the "OK" key, another window does not open but you immediately switch to the next mode. Press again to switch to the next mode. Only by pressing the arrow keys, you switch to the next setting menu.

	Virtual scaling
	Length scaling
	Diameter scaling

5.4.6 Aspect ratio

If you confirm this item with the "OK" key, another window does not open but you immediately switch to the next mode. Press again to switch to the next mode. Only by pressing the arrow keys, you switch to the next setting menu.

	Set image scale to 4:3
	Set image scale to 16:9

5.5 Recording images and videos

In view/operating mode, a short press on the recording key is enough for an image to be recorded. While the image is being saved, a small icon to the left of the date indicates the status. For a video, you have to hold down the recording key for approx. 3 seconds. Again, a red "REC" to the left of the date indicates that recording is in progress. To stop the recording, press and hold the recording key again for 3 seconds.

The names of the saved images and videos consist of the date and time, which makes it easier to assign them later.

5.6 Recalling the saved data

If you press the back key in display/operating mode, all the images you have taken are first displayed in small format. You can select one with the arrow keys and display it in large format by confirming with the "OK" key. By pressing the back key again, you can go back to the listing in small format.

If you now press the back button again, you will see the list of recorded videos. Here, you can also select one with the arrow keys and have it displayed in large format by pressing the "OK" key. Press the back key to go back to small view and press it again to return to operating mode.

6 Troubleshooting

Problem	Cause	Solution
No response when switched on	Battery flat	Charge battery
Instrument switches off	Insufficient power supply	Charge or replace the battery
The start screen freezes	System start-up failed or insufficient power supply	Switch off the instrument / remove the battery and reinsert it / force a reset - the switch is next to the SD card slot (small hole)
Image/video cannot be recorded or found	Capacity of SD card not sufficient	Replace the SD card or delete unusable files
Image freezes and instrument cannot be switched off	System got stuck	Force a reset - the switch is next to the SD card slot (small hole)

7 Warranty

You can read our warranty terms in our General Business Terms which you can find here: <https://www.pce-instruments.com/english/terms>.

8 Disposal

For the disposal of batteries in the EU, the 2006/66/EC directive of the European Parliament applies. Due to the contained pollutants, batteries must not be disposed of as household waste. They must be given to collection points designed for that purpose.

In order to comply with the EU directive 2012/19/EU we take our devices back. We either re-use them or give them to a recycling company which disposes of the devices in line with law.

For countries outside the EU, batteries and devices should be disposed of in accordance with your local waste regulations.

If you have any questions, please contact PCE Instruments.





PCE Instruments contact information

Germany

PCE Deutschland GmbH
Im Langel 26
D-59872 Meschede
Deutschland
Tel.: +49 (0) 2903 976 99 0
Fax: +49 (0) 2903 976 99 29
info@pce-instruments.com
www.pce-instruments.com/deutsch

United Kingdom

PCE Instruments UK Ltd
Unit 11 Southpoint Business Park
Ensign Way, Southampton
Hampshire
United Kingdom, SO31 4RF
Tel: +44 (0) 2380 98703 0
Fax: +44 (0) 2380 98703 9
info@pce-instruments.co.uk
www.pce-instruments.com/english

The Netherlands

PCE Brookhuis B.V.
Institutenweg 15
7521 PH Enschede
Nederland
Telefoon: +31 (0)53 737 01 92
info@pcebenelux.nl
www.pce-instruments.com/dutch

France

PCE Instruments France EURL
23, rue de Strasbourg
67250 Soultz-Sous-Forets
France
Téléphone: +33 (0) 972 3537 17
Numéro de fax: +33 (0) 972 3537 18
info@pce-france.fr
www.pce-instruments.com/french

Italy

PCE Italia s.r.l.
Via Pesciatina 878 / B-Interno 6
55010 Loc. Gragnano
Capannori (Lucca)
Italia
Telefono: +39 0583 975 114
Fax: +39 0583 974 824
info@pce-italia.it
www.pce-instruments.com/italiano

United States of America

PCE Americas Inc.
1201 Jupiter Park Drive, Suite 8
Jupiter / Palm Beach
33458 FL
USA
Tel: +1 (561) 320-9162
Fax: +1 (561) 320-9176
info@pce-americas.com
www.pce-instruments.com/us

Spain

PCE Ibérica S.L.
Calle Mayor, 53
02500 Tobarra (Albacete)
España
Tel. : +34 967 543 548
Fax: +34 967 543 542
info@pce-iberica.es
www.pce-instruments.com/espanol

Turkey

PCE Teknik Cihazları Ltd.Şti.
Halkalı Merkez Mah.
Pehlivan Sok. No.6/C
34303 Küçükçekmece - İstanbul
Türkiye
Tel: 0212 471 11 47
Faks: 0212 705 53 93
info@pce- cihazlari.com.tr
www.pce-instruments.com/turkish